

C200H - LK201  
3G2C7 - LK201  
3G2A6 - LK201  
CV500 - LK201 (Port 1)

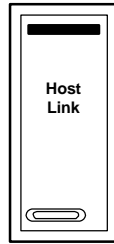

25-pin

### Cable Part Number C500 - CN221 - EU

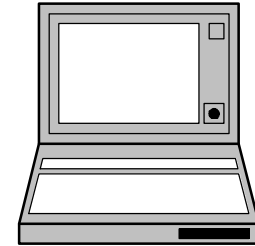

AT Computer (9-pin)

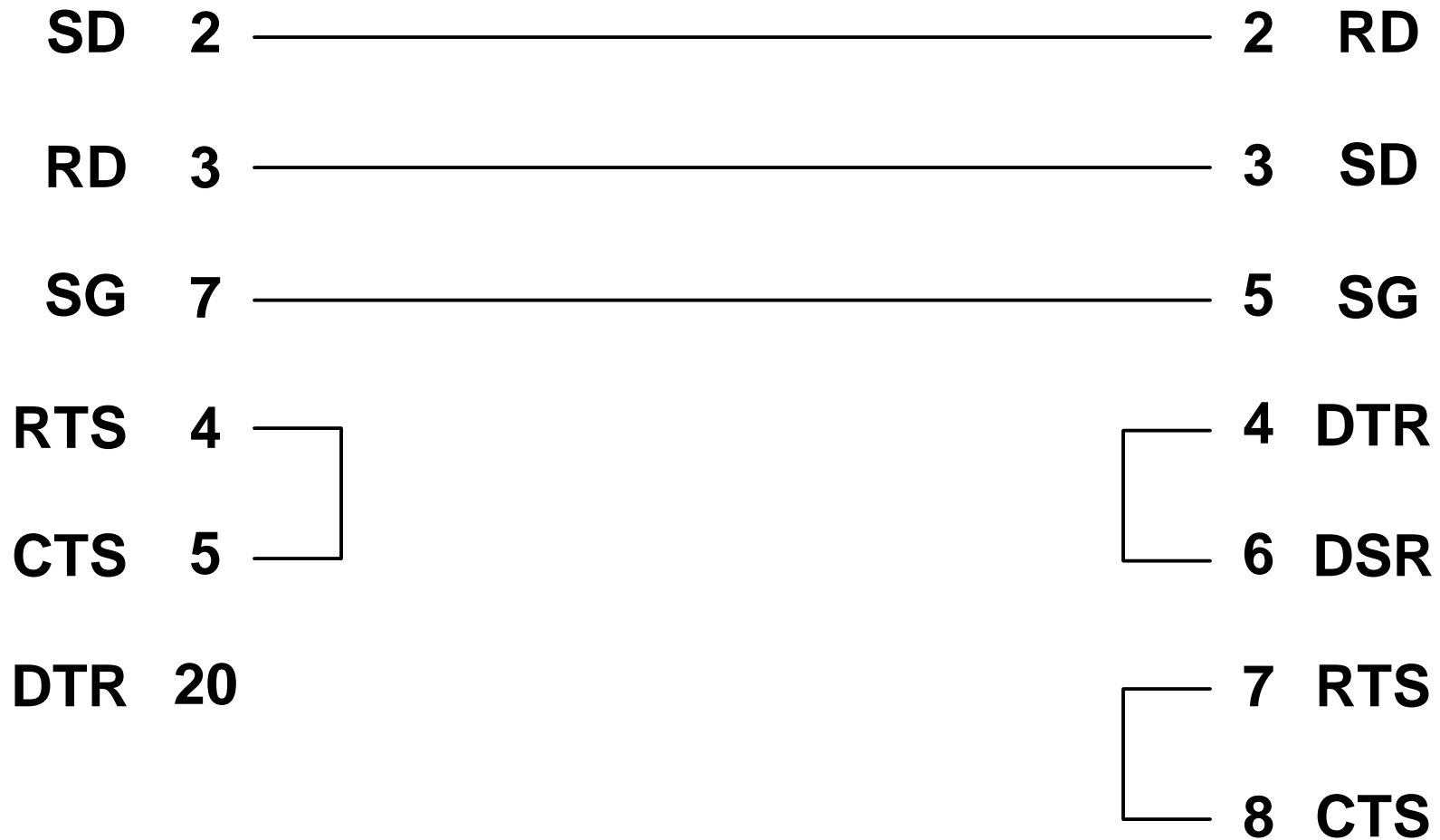

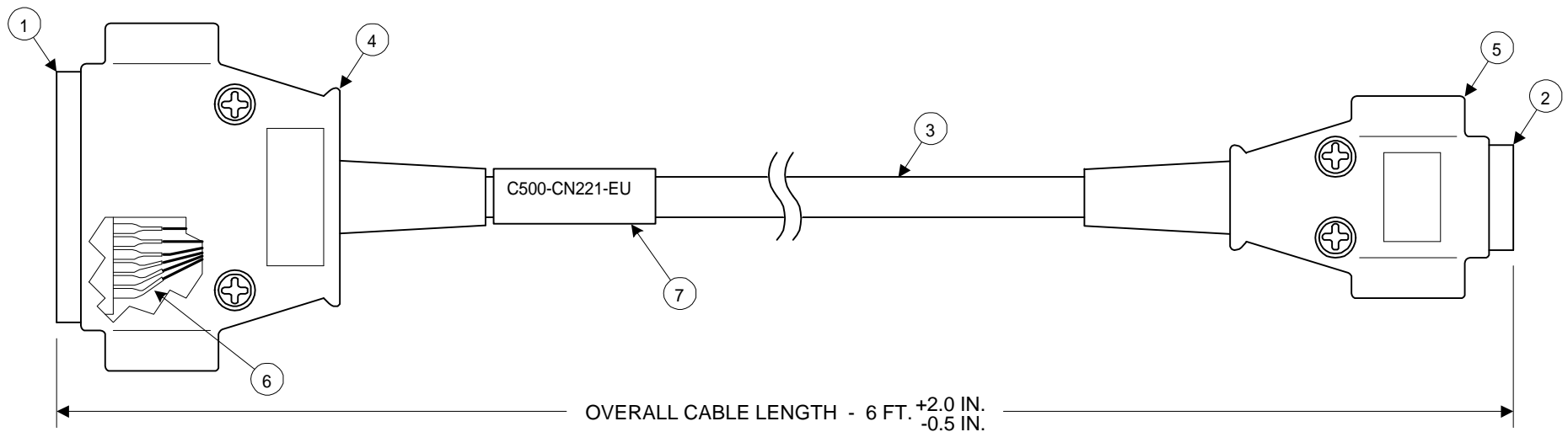

CABLE C500-CN221-EU

1. DB-25 MALE CONNECTOR WITH SOLDER CUPS
2. DE-9 FEMALE CONNECTOR WITH SOLDER CUPS
3. 3 CONDUCTOR, 24 AWG STRANDED, FOIL SHIELD, PVC JACKETED CABLE
4. OMRON DB-25 BACKSHEL W/ 2.6MM JACK SCREWS, P/N XM2S-2511
5. OMRON DE-9 BACKSHELL W/ #4-40 JACK SCREWS, P/N XM2S-0913
6. HEAT SHRINK TUBING TO COVER SOLDERED CONNECTION, BOTH ENDS
7. HEAT SHRINK TUBING, WHITE WITH PRINTED PART NUMBER AS SHOWN IN BLACK, 8 PT. HELVETICA. POSITION APPROXIMATELY AS SHOWN.

	FROM #1 PIN	TO #2 PIN	
TXD	2	2	RXD
RXD	3	3	TXD
	*4 to 5	nc	
	nc	*4 to 6	
	nc	*7 to 8	
COM	7	5	COM
	1 to SHIELD	nc	

\* PIN TO PIN JUMPERS

-	-	-	-	-	APPROVAL	DATE	MATERIAL: -	C500 BASIC/ASCII/LINK TO IBM-AT COMPUTER CABLE	
-	-	-	-	-	DRWN OBA	11-2-94	FINISH: -		
-	-	-	-	-	CHCKD	-	TOLERANCE: -	UNITS: ENGLISH	DRWG NO: PFP0015A
-	-	-	-	-	APRVD	-		SCALE: NONE	FILE NAME: - SIZE: A
REV	DESCRIPTION	COS NO.	DATE	SGND				SHEET: 1 OF 1	<b>OMRON</b> Omron Electronics, Inc. Omron Manufacturing of America

C200H - LK201  
3G2C7 - LK201  
3G2A6 - LK201  
CV500 - LK201 (Port 1)



25-pin

### Cable Part Number

C500 - CN222 - EU

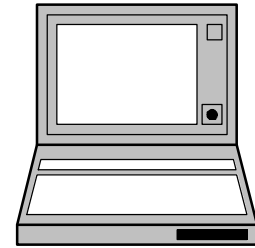

XT Computer (25-pin)

**SD 2** ————— **3 RD**

**RD 3** ————— **2 SD**

**SG 7** ————— **7 SG**

**RTS 4** 

**CTS 5** 

**DTR 20**

 **6 DSR**

 **20 DTR**

 **4 RTS**

 **5 CTS**



CV500 - LK201 (Port 2)  
 CVM1 built-in Hostlink  
 C200HS built-in Hostlink  
 CQM1 built-in Hostlink  
 IDSC built-in Hostlink

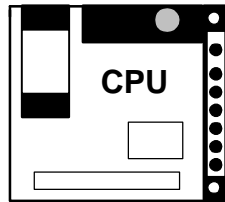

9-pin

### Cable Part Number

C200HS - CN220 - EU

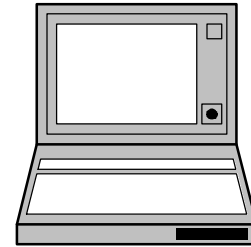

AT Computer (9-pin)

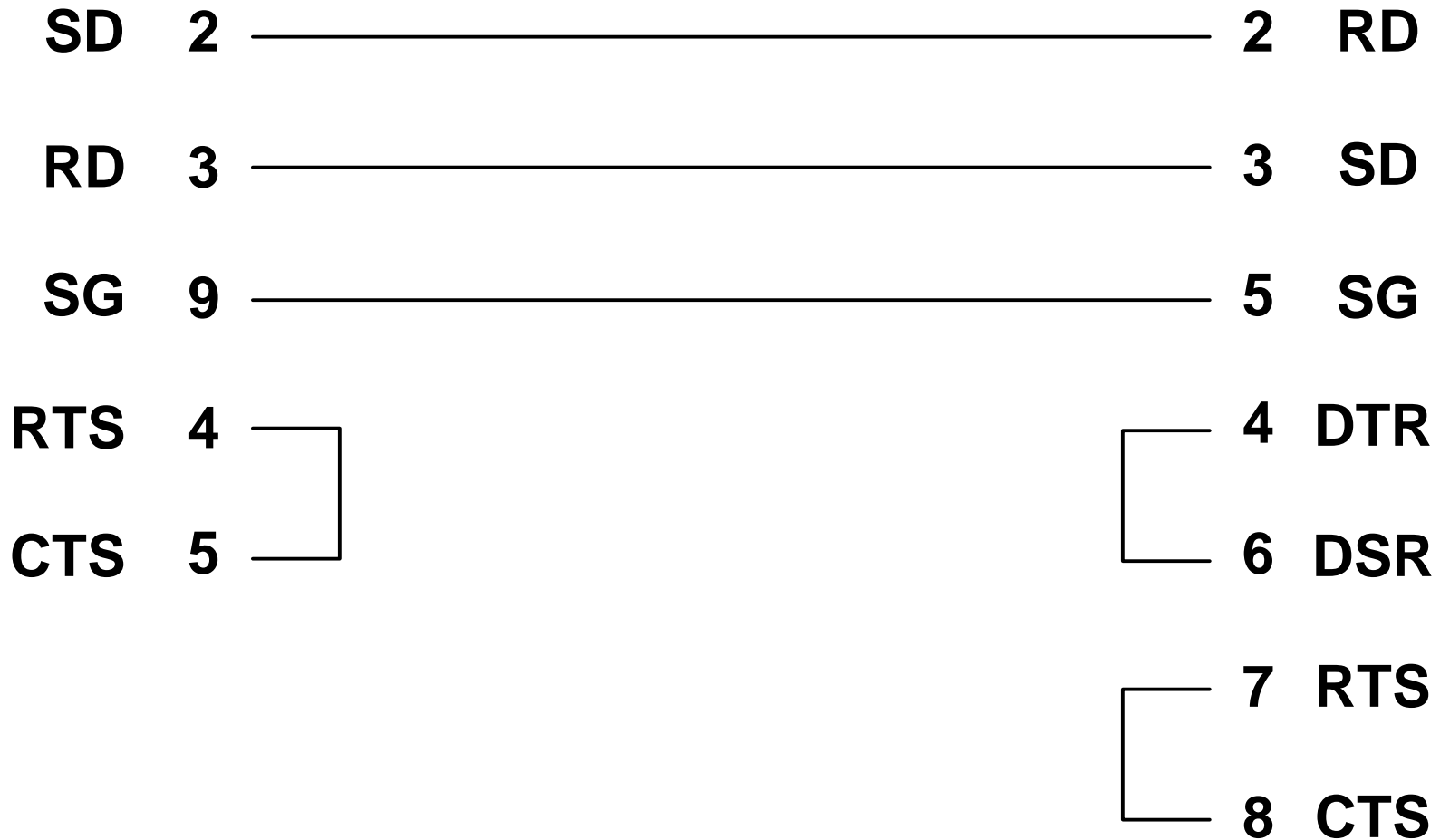

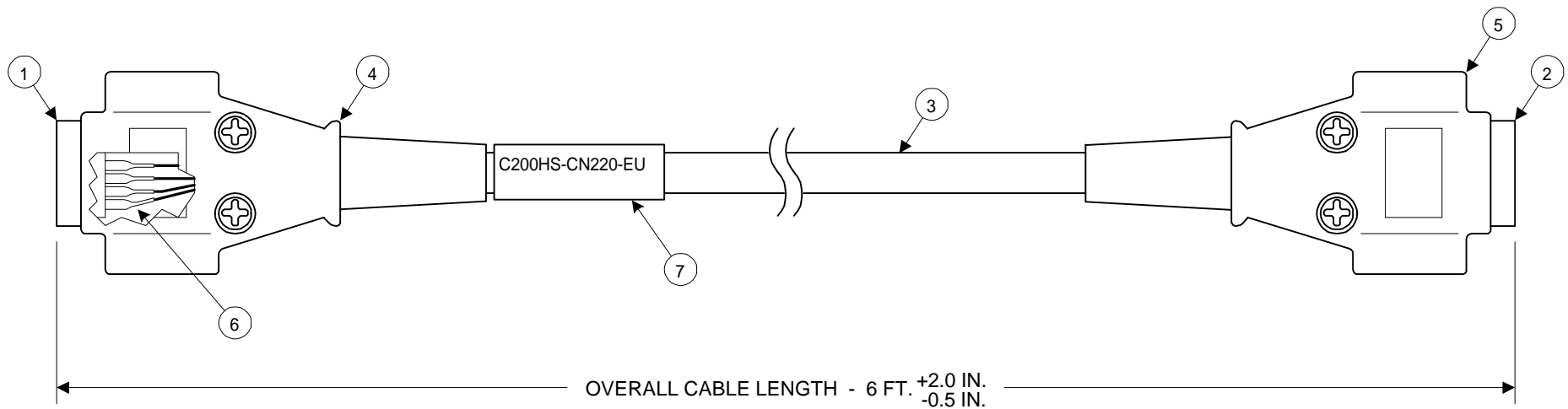

CABLE C200HS-CN220-EU

1. DE-9 MALE CONNECTOR WITH SOLDER CUPS
2. DE-9 FEMALE CONNECTOR WITH SOLDER CUPS
3. 3 CONDUCTOR, 24 AWG STRANDED, FOIL SHIELD, PVC JACKETED CABLE
4. OMRON DE-9 BACKSHELL W/ 2.6MM JACK SCREWS, P/N XM2S-0911
5. OMRON DE-9 BACKSHELL W/ #4-40 JACK SCREWS, P/N XM2S-0913
6. HEAT SHRINK TUBING TO COVER SOLDERED CONNECTION, BOTH ENDS
7. HEAT SHRINK TUBING, WHITE WITH PRINTED PART NUMBER AS SHOWN IN BLACK, 8 PT. HELVETICA. POSITION APPROXIMATELY AS SHOWN.

	FROM #1 PIN	TO #2 PIN	
TXD	2	2	RXD
RXD	3	3	TXD
	*4 to 5	nc	
	nc	*4 to 6	
	nc	*7 to 8	
SG	9	5	SG
	1 to SHIELD	nc	

\* PIN TO PIN JUMPERS

-	-	-	-	-	APPROVAL	DATE	MATERIAL: -	HOST LINK PORT TO IBM-AT COMPUTER CABLE	
-	-	-	-	-	DRWN OBA	10-26-94	FINISH: -		
-	-	-	-	-	CHCKD	-	TOLERANCE: -	UNITS: ENGLISH	DRWG NO: PFP0010A
-	-	-	-	-	APRVD	-		SCALE: NONE	FILE NAME: -
REV	DESCRIPTION	COS NO.	DATE	SGND				SHEET: 1 OF 1	SIZE: A
								Omron Electronics, Inc. Omron Manufacturing of America	



CVM1 built-in Hostlink  
C200HS built-in Hostlink  
CQM1 built-in Hostlink

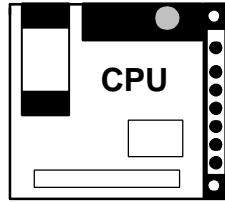

9-pin

## Cable Part Number

C200HS - CN229 - EU

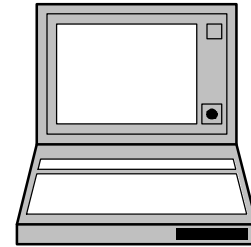

XT Computer (25-pin)

**SD 2** \_\_\_\_\_ **3 RD**

**RD 3** \_\_\_\_\_ **2 SD**

**SG 9** \_\_\_\_\_ **7 SG**

**RTS 4**   
**CTS 5**

**6 DSR**   
**20 DTR**

**4 RTS**   
**5 CTS**



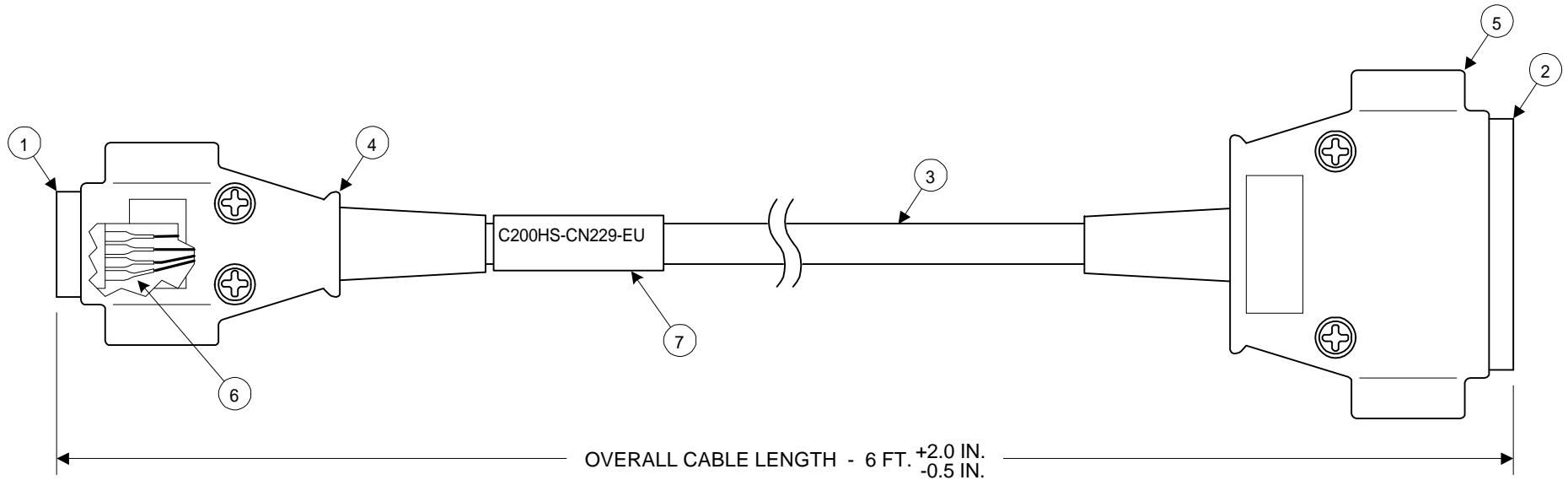

CABLE C200HS-CN229-EU

1. DE-9 MALE CONNECTOR WITH SOLDER CUPS
2. DE-25 FEMALE CONNECTOR WITH SOLDER CUPS
3. 3 CONDUCTOR, 24 AWG STRANDED, FOIL SHIELD, PVC JACKETED CABLE
4. OMRON DE-9 BACKSHELL W/ 2.6MM JACK SCREWS, P/N XM2S-0911
5. OMRON DE-25 BACKSHELL W/ #4-40 JACK SCREWS, P/N XM2S-2513
6. HEAT SHRINK TUBING TO COVER SOLDERED CONNECTION, BOTH ENDS
7. HEAT SHRINK TUBING, WHITE WITH PRINTED PART NUMBER AS SHOWN IN BLACK, 8 PT. HELVETICA. POSITION APPROXIMATELY AS SHOWN.

	FROM #1 PIN	TO #2 PIN	
TXD	2	3	RXD
RXD	3	2	TXD
	*4 to 5	nc	
	nc	*6 to 20	
	nc	*4 to 5	
SG	9	7	SG
	1 to SHIELD	nc	

\* PIN TO PIN JUMPERS

-	-	-	-	-	APPROVAL	DATE	MATERIAL: -	HOST LINK PORT TO IBM-XT COMPUTER CABLE		
-	-	-	-	-	DRWN OBA	10-26-94	FINISH: -			
-	-	-	-	-	CHCKD	-	TOLERANCE: -	UNITS: ENGLISH	DRWG NO: PFP0011A	
-	-	-	-	-	APRVD	-		SCALE: NONE	FILE NAME: -	SIZE: A
REV	DESCRIPTION	COS NO.	DATE	SGND	-	-		SHEET: 1 OF 1	Omron Electronics, Inc. Omron Manufacturing of America	

C200H-ASC02  
C200H-BASIC/ASCII

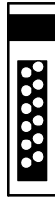

### Cable Part Number

C200H - CN220 - EU

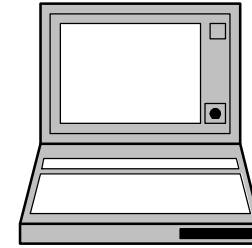

XT Computer (25-pin)

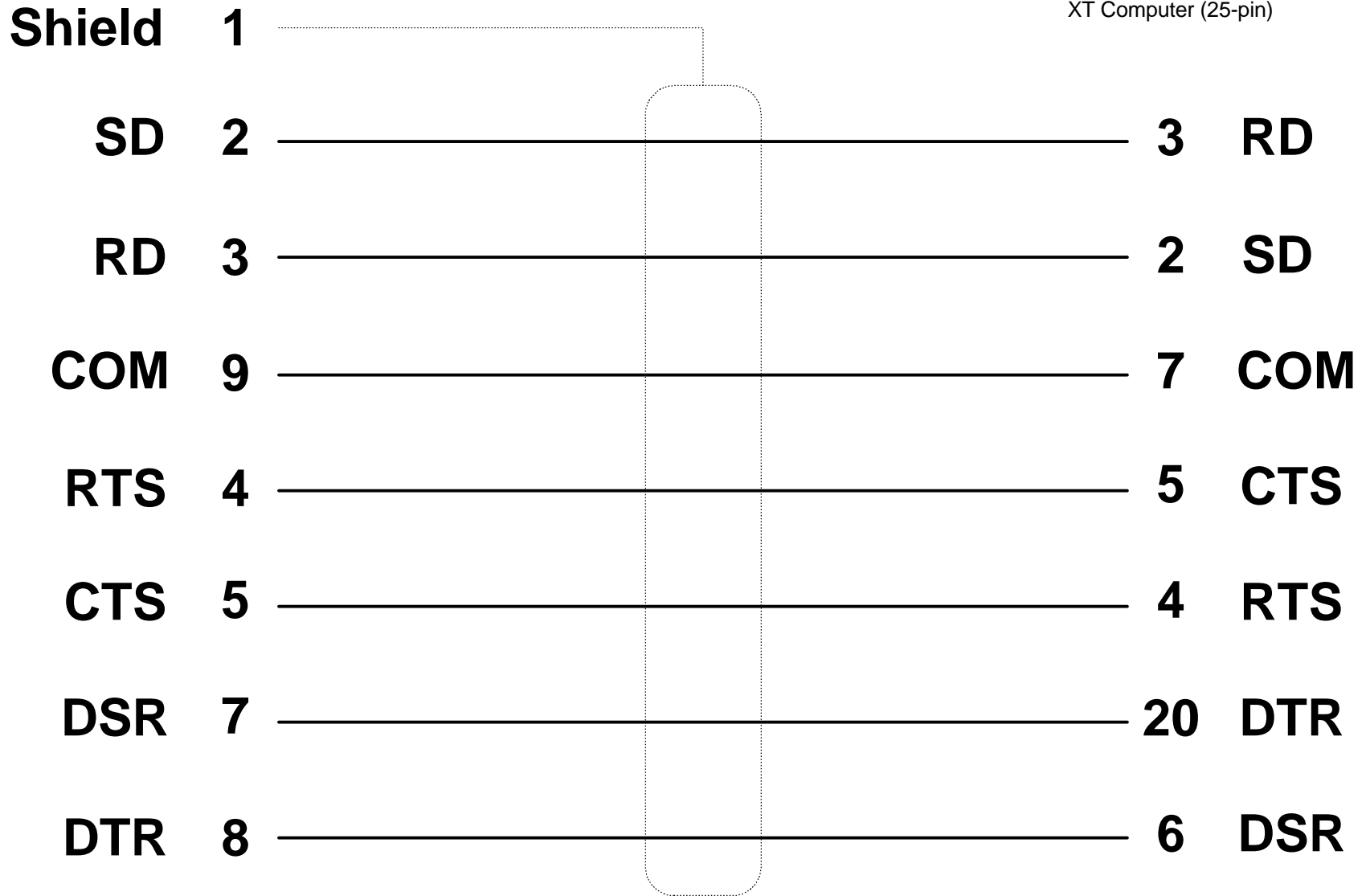

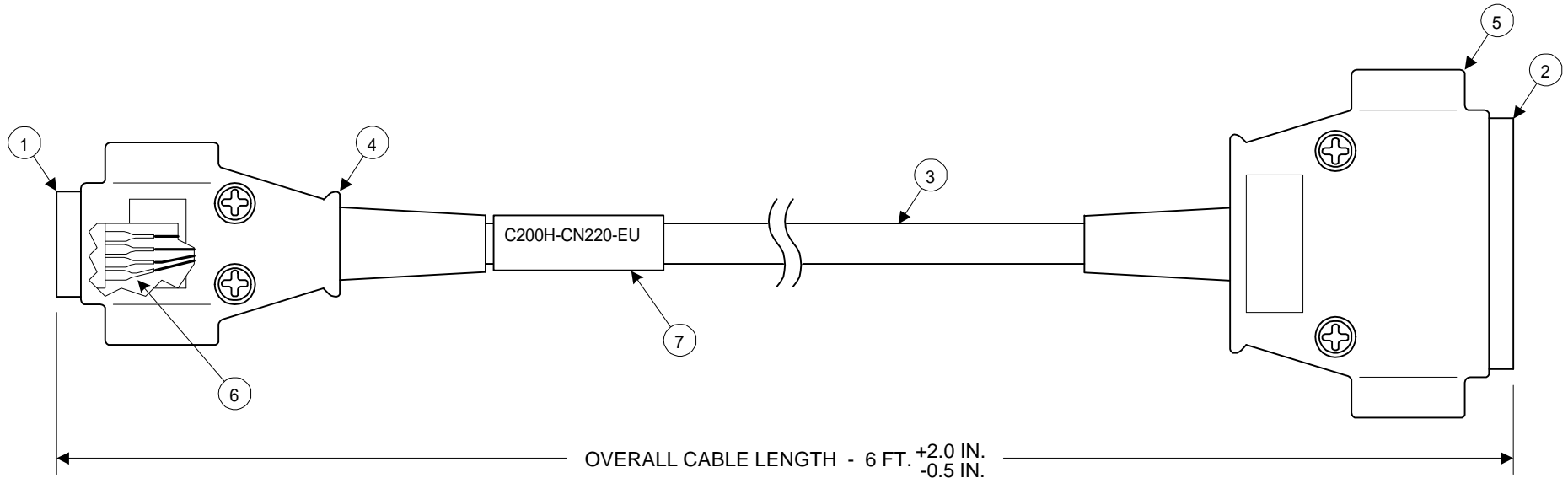

CABLE C200H-CN220-EU

1. DE-9 MALE CONNECTOR WITH SOLDER CUPS
2. DB-25 FEMALE CONNECTOR WITH SOLDER CUPS
3. 7 CONDUCTOR, 24 AWG STRANDED, FOIL SHIELD, PVC JACKETED CABLE
4. OMRON DE-9 BACKSHELL W/ 2.6MM JACK SCREWS, P/N XM2S-0911
5. OMRON DB-25 BACKSHELL W/ #4-40 JACK SCREWS, P/N XM2S-2513
6. HEAT SHRINK TUBING TO COVER SOLDERED CONNECTION, BOTH ENDS
7. HEAT SHRINK TUBING, WHITE WITH PRINTED PART NUMBER AS SHOWN IN BLACK, 8 PT. HELVETICA. POSITION APPROXIMATELY AS SHOWN.

	FROM #1 PIN	TO #2 PIN	
	TXD 2	3	RXD
	RXD 3	2	TXD
	RTS 4	5	CTS
	CTS 5	4	RTS
	6	nc	
	DSR 7	20	DTR
	DTR 8	6	DSR
	COM 9	7	COM
	1 to SHIELD	nc	

-	-	-	-	-	APPROVAL	DATE	MATERIAL: -	C200H BASIC/ASCII MODULE TO IBM-XT COMPUTER CABLE	
-	-	-	-	-	DRWN OBA	10-18-94	FINISH: -		
B	ADDED ITEMS #6 AND 7	-	10-18-94	-	CHCKD	-	TOLERANCE: -	UNITS: ENGLISH	DRWG NO: PFP0006B
A	ORIGINAL	-	7-14-94	-	APRVD	-		SCALE: NONE	FILE NAME: - SIZE: A
REV	DESCRIPTION	COS NO.	DATE	SGND				SHEET: 1 OF 1	<b>OMRON</b> Omron Electronics, Inc. Omron Manufacturing of America

C200H-ASC02  
C200H-BASIC/ASCII

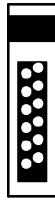

### Cable Part Number

C200H - CN229 - EU

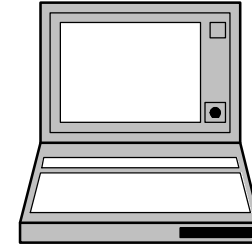

AT Computer (9-pin)

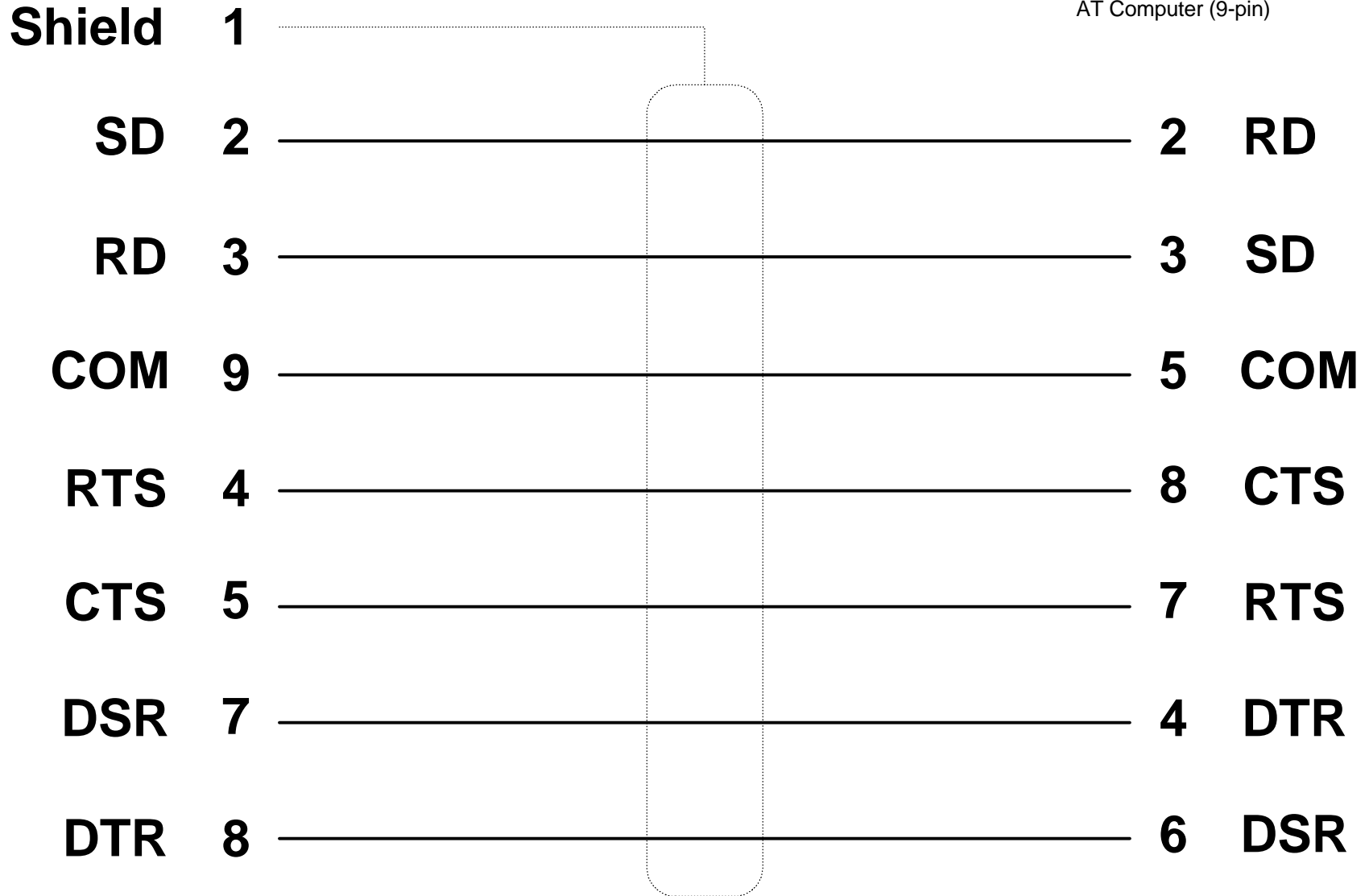

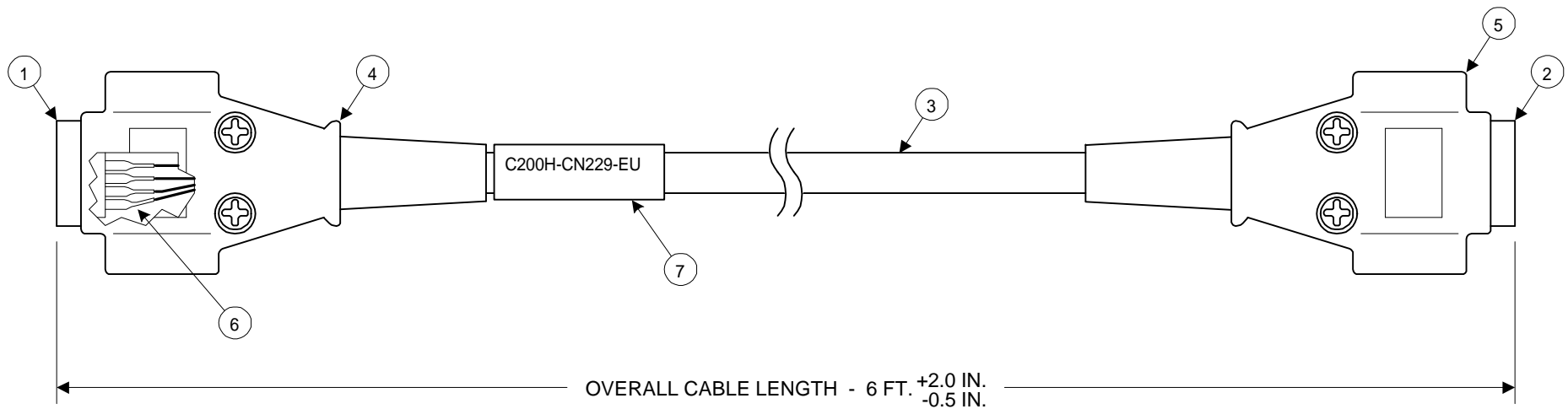

CABLE C200H-CN229-EU

1. DE-9 MALE CONNECTOR WITH SOLDER CUPS
2. DE-9 FEMALE CONNECTOR WITH SOLDER CUPS
3. 7 CONDUCTOR, 24 AWG STRANDED, FOIL SHIELD, PVC JACKETED CABLE
4. OMRON DE-9 BACKSHELL W/ 2.6MM JACK SCREWS, P/N XM2S-0911
5. OMRON DE-9 BACKSHELL W/ #4-40 JACK SCREWS, P/N XM2S-0913
6. HEAT SHRINK TUBING TO COVER SOLDERED CONNECTION, BOTH ENDS
7. HEAT SHRINK TUBING, WHITE WITH PRINTED PART NUMBER AS SHOWN IN BLACK, 8 PT. HELVETICA. POSITION APPROXIMATELY AS SHOWN.

	FROM #1 PIN	TO #2 PIN	
	TXD 2	2	RXD
	RXD 3	3	TXD
	RTS 4	8	CTS
	CTS 5	7	RTS
	6	nc	
	DSR 7	4	DTR
	DTR 8	6	DSR
	COM 9	5	COM
	1 to SHIELD	nc	

-	-	-	-	-	APPROVAL	DATE	MATERIAL: -	C200H BASIC/ASCII MODULE TO IBM-AT COMPUTER CABLE	
-	-	-	-	-	DRWN OBA	10-18-94	FINISH: -		
B	ADDED ITEMS #6 AND 7	-	10-18-94	-	CHCKD	-	TOLERANCE: -	UNITS: ENGLISH	DRWG NO: PFP0005B
A	ORIGINAL	-	7-14-94	-	APRVD	-		SCALE: NONE	FILE NAME: - SIZE: A
REV	DESCRIPTION	COS NO.	DATE	SGND				SHEET: 1 OF 1	<b>OMRON</b> Omron Electronics, Inc. Omron Manufacturing of America

NT11S, NT20S,  
NT600S, NT30,  
NT30C, NT620S/620C

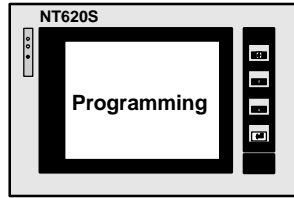

### Cable Part Number C200H - CN229 - EU

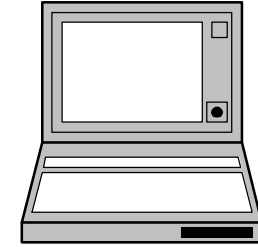

9-pin

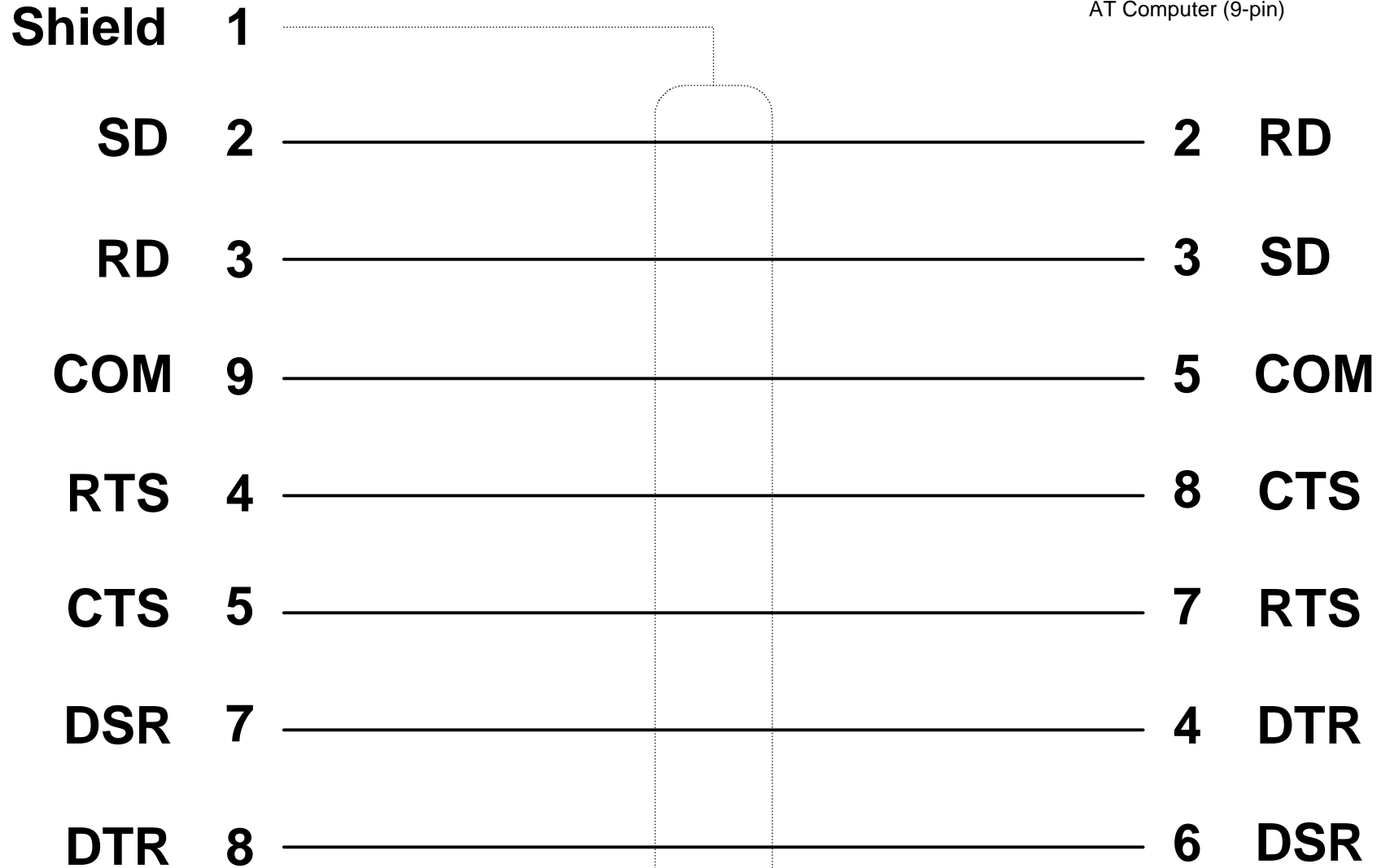

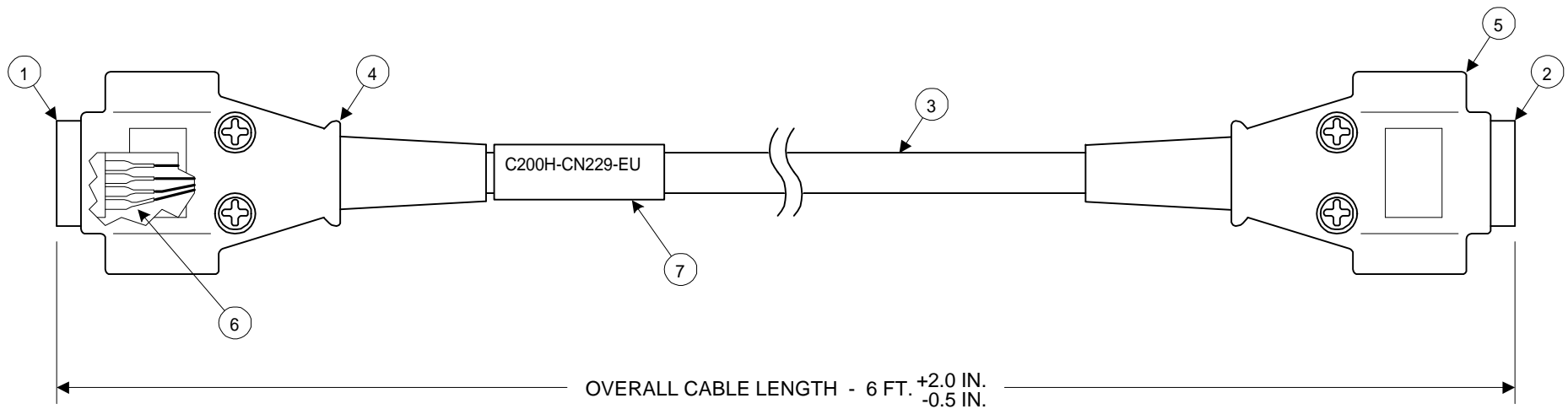

CABLE C200H-CN229-EU

1. DE-9 MALE CONNECTOR WITH SOLDER CUPS
2. DE-9 FEMALE CONNECTOR WITH SOLDER CUPS
3. 7 CONDUCTOR, 24 AWG STRANDED, FOIL SHIELD, PVC JACKETED CABLE
4. OMRON DE-9 BACKSHELL W/ 2.6MM JACK SCREWS, P/N XM2S-0911
5. OMRON DE-9 BACKSHELL W/ #4-40 JACK SCREWS, P/N XM2S-0913
6. HEAT SHRINK TUBING TO COVER SOLDERED CONNECTION, BOTH ENDS
7. HEAT SHRINK TUBING, WHITE WITH PRINTED PART NUMBER AS SHOWN IN BLACK, 8 PT. HELVETICA. POSITION APPROXIMATELY AS SHOWN.

	FROM #1 PIN	TO #2 PIN	
	TXD 2	2	RXD
	RXD 3	3	TXD
	RTS 4	8	CTS
	CTS 5	7	RTS
	6	nc	
	DSR 7	4	DTR
	DTR 8	6	DSR
	COM 9	5	COM
	1 to SHIELD	nc	

-	-	-	-	-	APPROVAL	DATE	MATERIAL: -	C200H BASIC/ASCII MODULE TO IBM-AT COMPUTER CABLE	
-	-	-	-	-	DRWN OBA	10-18-94	FINISH: -		
B	ADDED ITEMS #6 AND 7	-	10-18-94	-	CHCKD	-	TOLERANCE: -	UNITS: ENGLISH	DRWG NO: PFP0005B
A	ORIGINAL	-	7-14-94	-	APRVD	-		SCALE: NONE	FILE NAME: - SIZE: A
REV	DESCRIPTION	COS NO.	DATE	SGND				SHEET: 1 OF 1	<b>OMRON</b> Omron Electronics, Inc. Omron Manufacturing of America

NT11S, NT20S,  
NT600S, NT30,  
NT30C, NT620S/620C

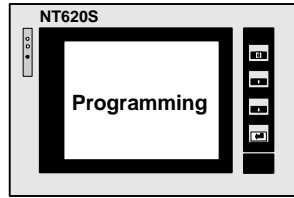

## Cable Part Number C200H - CN220 - EU

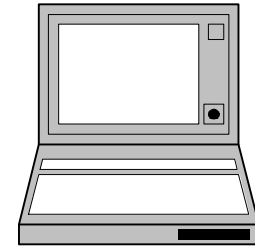

XT Computer (25-pin)

9-pin

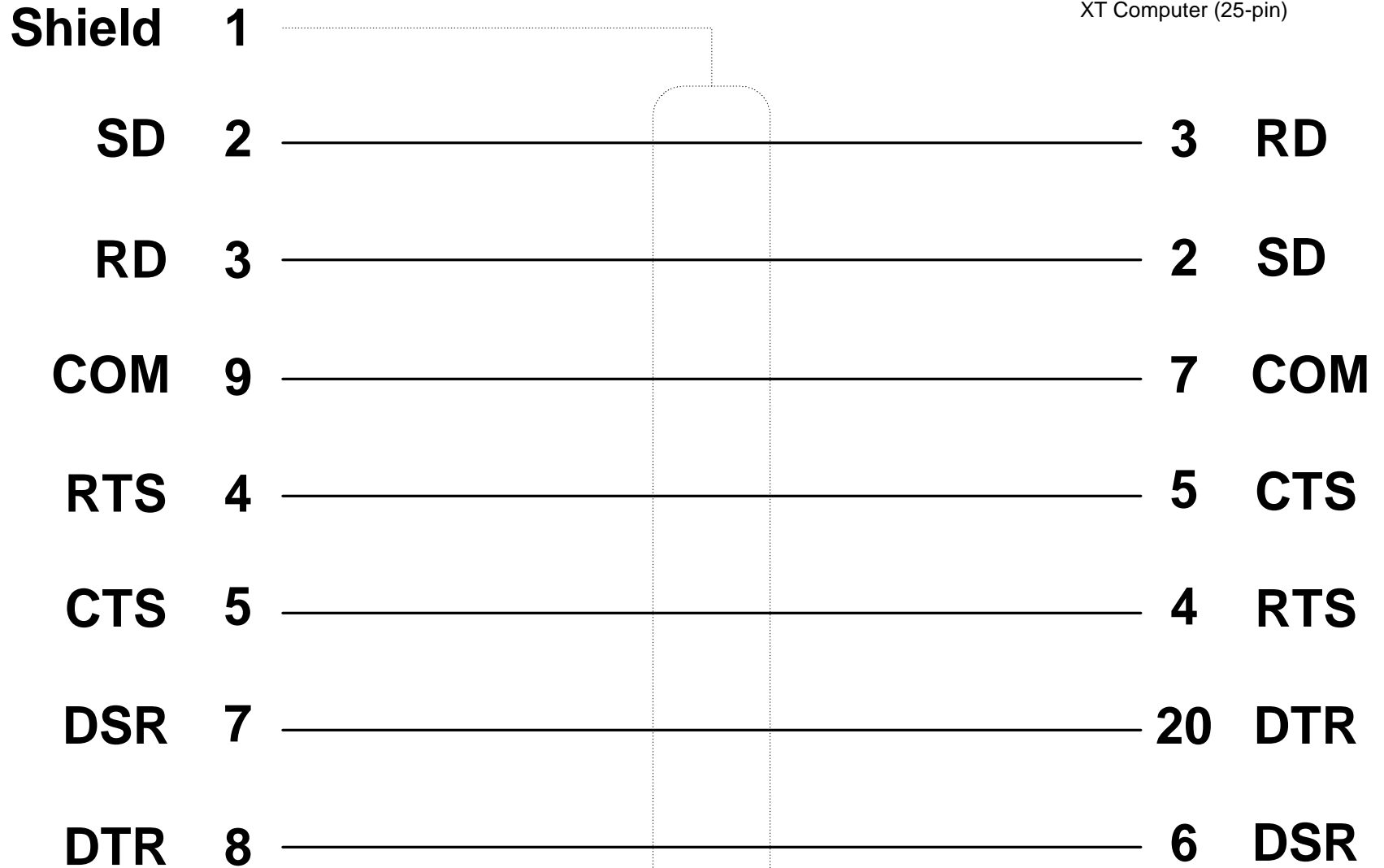



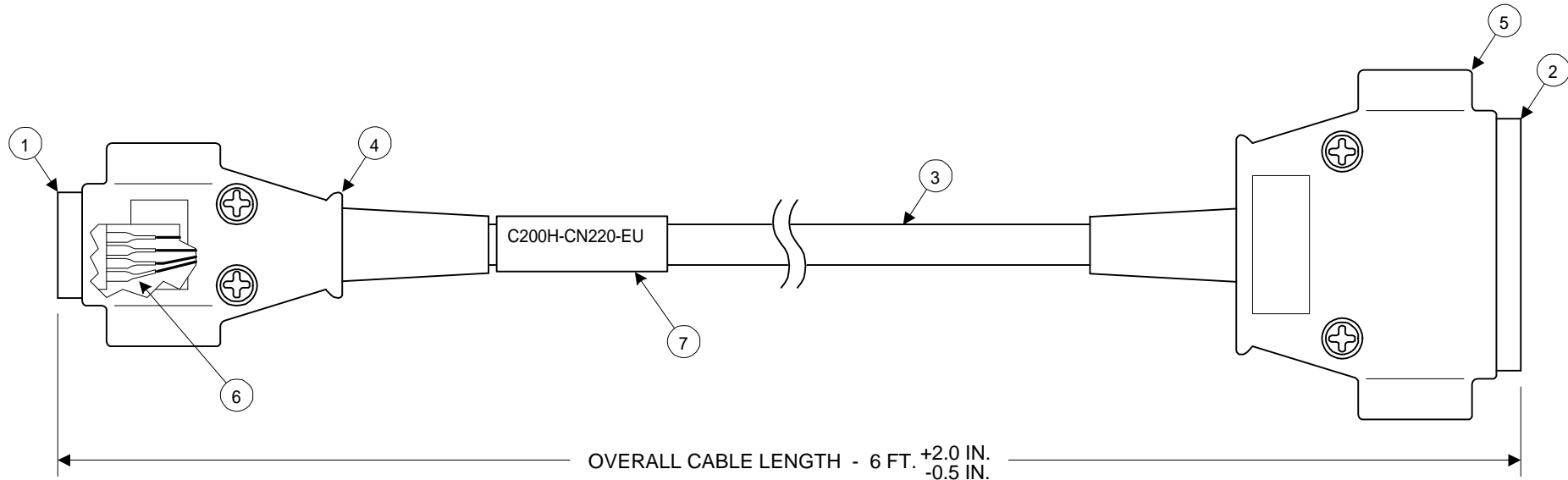

CABLE C200H-CN220-EU

1. DE-9 MALE CONNECTOR WITH SOLDER CUPS
2. DB-25 FEMALE CONNECTOR WITH SOLDER CUPS
3. 7 CONDUCTOR, 24 AWG STRANDED, FOIL SHIELD, PVC JACKETED CABLE
4. OMRON DE-9 BACKSHELL W/ 2.6MM JACK SCREWS, P/N XM2S-0911
5. OMRON DB-25 BACKSHELL W/ #4-40 JACK SCREWS, P/N XM2S-2513
6. HEAT SHRINK TUBING TO COVER SOLDERED CONNECTION, BOTH ENDS
7. HEAT SHRINK TUBING, WHITE WITH PRINTED PART NUMBER AS SHOWN IN BLACK, 8 PT. HELVETICA. POSITION APPROXIMATELY AS SHOWN.

FROM #1 PIN	TO #2 PIN
TXD 2	3 RXD
RXD 3	2 TXD
RTS 4	5 CTS
CTS 5	4 RTS
6	nc
DSR 7	20 DTR
DTR 8	6 DSR
COM 9	7 COM
1 to SHIELD	nc

-	-	-	-	-	APPROVAL	DATE	MATERIAL: -	C200H BASIC/ASCII MODULE TO IBM-XT COMPUTER CABLE	
-	-	-	-	-	DRWN	OBA	10-18-94		
B	ADDED ITEMS #6 AND 7	-	10-18-94	-	CHCKD	-	-	UNITS: ENGLISH	DRWG NO: PFP0006B
A	ORIGINAL	-	7-14-94	-	APRVD	-	-	SCALE: NONE	FILE NAME: - SIZE: A
REV	DESCRIPTION	COS NO.	DATE	SGND	-	-	-	SHEET: 1 OF 1	<b>OMRON</b> Omron Electronics, Inc. Omron Manufacturing of America

NT11S, NT20S,  
NT600S, NT30,  
NT30C, NT620/620S

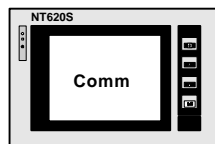

9-pin male

**Cable Part Number**  
**C200H - CN510 - EU**

CV500 - LK201 (Port 2)  
CVM1 built-in port  
C200HS built-in port  
CQM1 built-in port  
IDSC built-in port

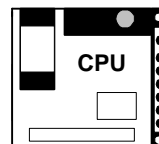

9-pin male

CV500-LK201 (Port 2)  
CVM1 built-in port  
C200HS built-in port  
CQM1 built-in port  
IDSC built-in port

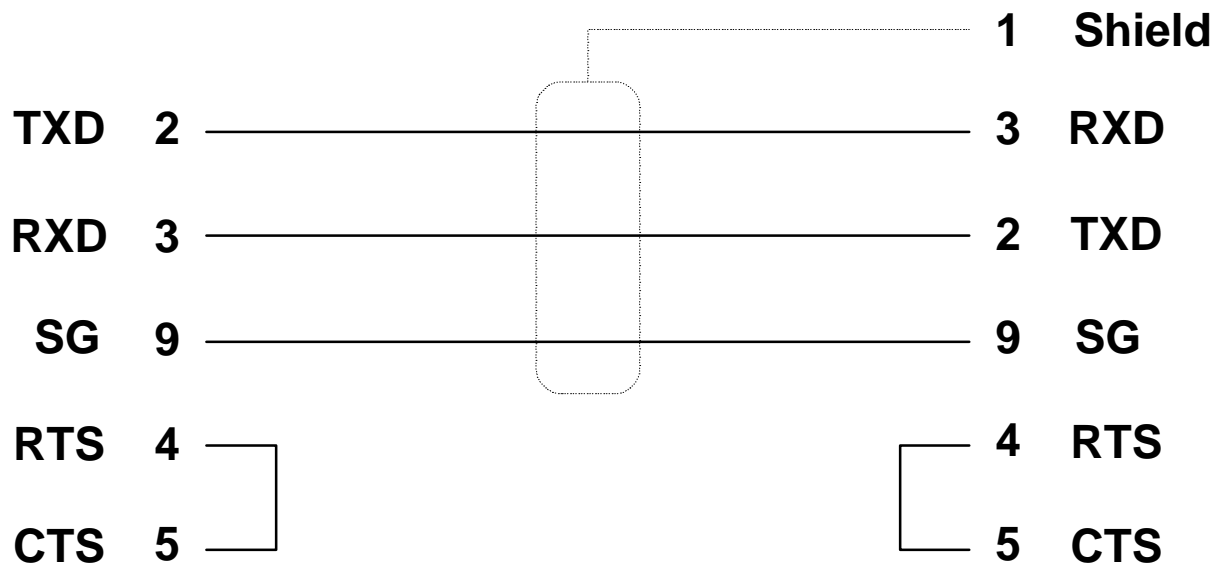
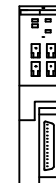

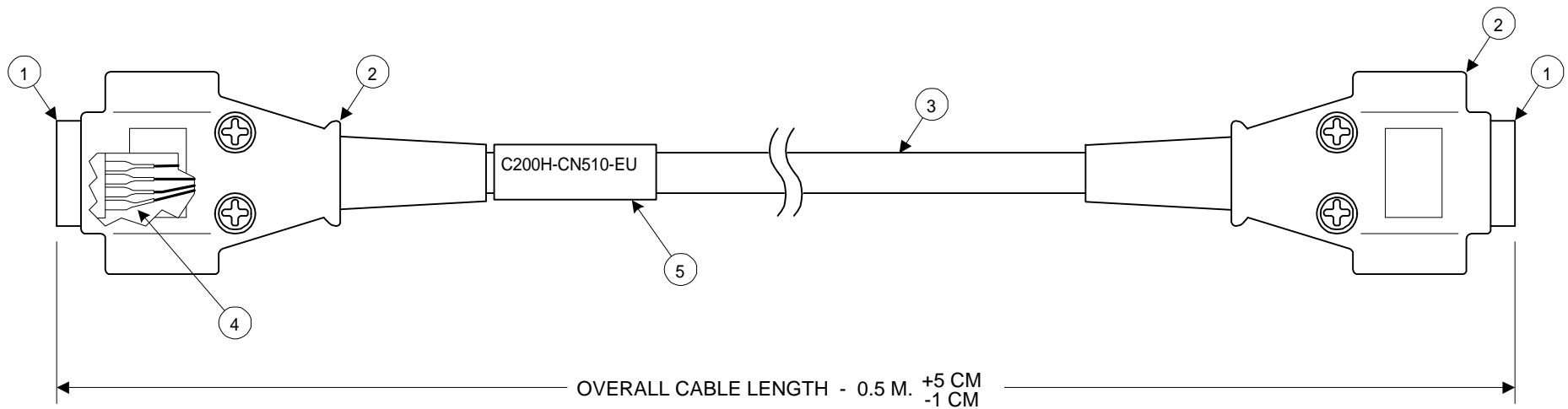

**CABLE C200H-CN510-EU**

1. DE-9 MALE CONNECTOR WITH SOLDER CUPS, QTY 2
2. OMRON DE-9 BACKSHELL W/ 2.6MM JACK SCREWS, QTY 2  
OMRON CAT. NO. XM2S-0911, PIM NO. 4584252-0
3. 3 CONDUCTOR, 24 AWG STRANDED, FOIL SHIELD, PVC JACKETED CABLE\*
4. HEAT SHRINK TUBING TO COVER SOLDERED CONNECTION, BOTH ENDS
5. HEAT SHRINK TUBING, WHITE WITH PRINTED PART NUMBER AS SHOWN IN BLACK, 8 PT. HELVETICA TYPE. POSITION APPROXIMATELY AS SHOWN.

\* RECOMMENDED: CAROL #C0743, 6 CONDUCTOR CABLE

	FROM PIN	TO PIN	
TXD	2	3	RXD
RXD	3	2	TXD
	nc	4 to 5*	
	4 to 5*	nc	
+5	6	nc	
COM	9	9	COM
	nc	1 to SHIELD	

\* JUMPER PINS 4 TO 5 IN EACH CONNECTOR

-	-	-	-	-	APPROVAL	DATE	MATERIAL: -	S-SERIES PT to C-CV SERIES CPU PORT	
-	-	-	-	-	DRWN OBA	11-28-95	FINISH: -		
-	-	-	-	-	CHCKD	-	TOLERANCE: -	UNITS: ENGLISH	DRWG NO: PFP0017-A
-	-	-	-	-	APRVD	-		SCALE: NONE	FILE NAME: -
REV	DESCRIPTION	COS NO.	DATE	SGND				SHEET: 1 OF 1	SIZE: A
								Omron Electronics, Inc. Omron Manufacturing of America	

NT11S, NT20S, NT30,  
NT30C, NT600S,  
NT620C/620S

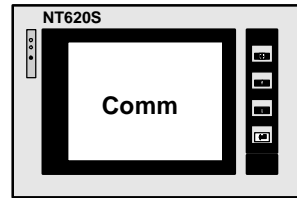

9-pin male

**Cable Part Number**  
**C200H-519-EU (50 cm)**  
**C200H-329-EU (3M)**  
**C200H-529-EU (5M)**

C500 - LK203  
 C200H - LK201  
 3G2A6 - LK201  
 3G2C7 - LK201  
 CV500 - LK201 (Port 1)

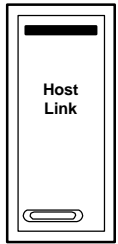

25-pin

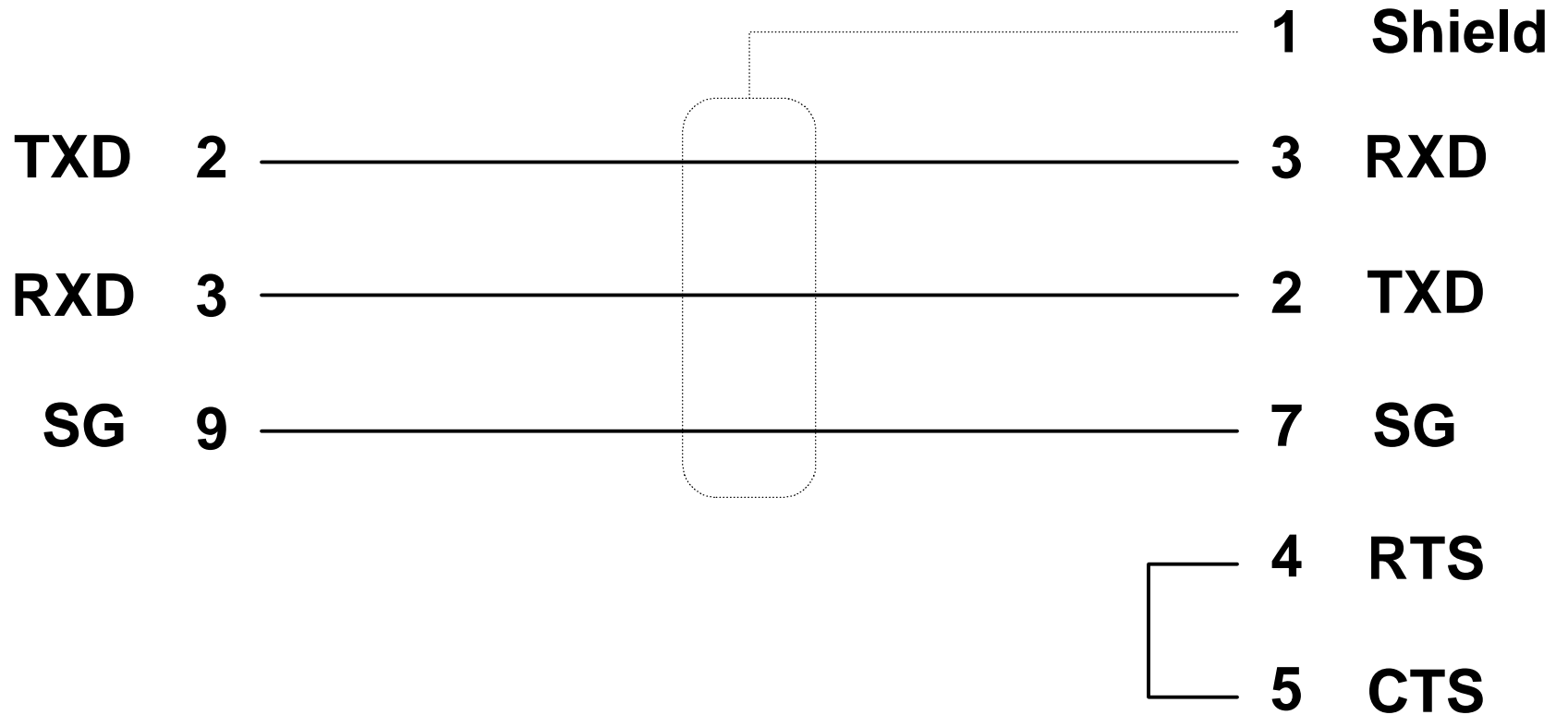

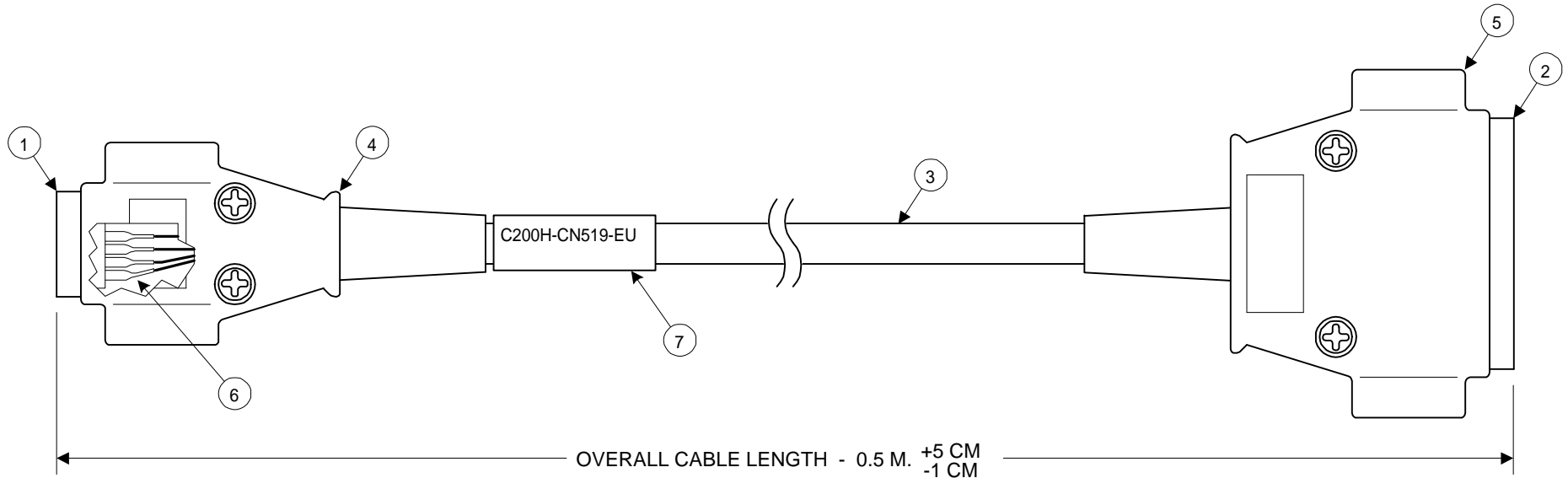

CABLE C200H-CN519-EU

1. DE-9 MALE CONNECTOR WITH SOLDER CUPS
2. DB-25 MALE CONNECTOR WITH SOLDER CUPS
3. 3 CONDUCTOR, 24 AWG STRANDED, FOIL SHIELD, PVC JACKETED CABLE
4. OMRON DE-9 BACKSHELL W/ 2.6MM JACK SCREWS, CAT. XM2S-0911, PIM 4584252-0
5. OMRON DB-25 BACKSHELL W/ 2.6MM JACK SCREWS, CAT. XM2S-2511, PIM 4584254-0
6. HEAT SHRINK TUBING TO COVER SOLDERED CONNECTION, BOTH ENDS
7. HEAT SHRINK TUBING, WHITE WITH PRINTED PART NUMBER AS SHOWN IN BLACK, 8 PT. HELVETICA TYPE. POSITION APPROXIMATELY AS SHOWN.

\* RECOMMENDED: CAROL #C0743, 6 CONDUCTOR CABLE

	FROM #1 PIN	TO #2 PIN	
TXD	2	3	RXD
RXD	3	2	TXD
	nc	4 to 5*	
	---	---	
+5	6	nc	
COM	9	7	COM
	nc	1 to SHIELD	

\* JUMPER PINS 4 TO 5

-	-	-	-	-	APPROVAL	DATE	MATERIAL: -	S-SERIES PT to C-CV SERIES HOST LINK MODULE	
-	-	-	-	-	DRWN OBA	11-28-95	FINISH: -		
-	-	-	-	-	CHCKD	-	TOLERANCE: -	UNITS: ENGLISH	DRWG NO: PFP0020-A
-	-	-	-	-	APRVD	-		SCALE: NONE	FILE NAME: -
REV	DESCRIPTION	COS NO.	DATE	SGND	-	-		SHEET: 1 OF 1	SIZE: A

**OMRON** Omron Electronics, Inc.  
Omron Manufacturing of America

CPM1 / CQM1 / C200H /  
IDSC

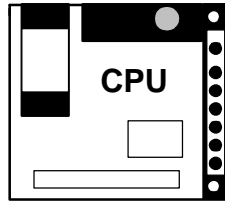

9-pin male

**Cable Part Number**  
C200H - CN320 - EU  
C200H - CN520 - EU  
(one-to-one link)

CPM1 / CQM1 / C200H /  
IDSC

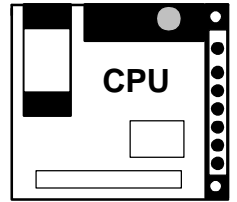

9-pin male

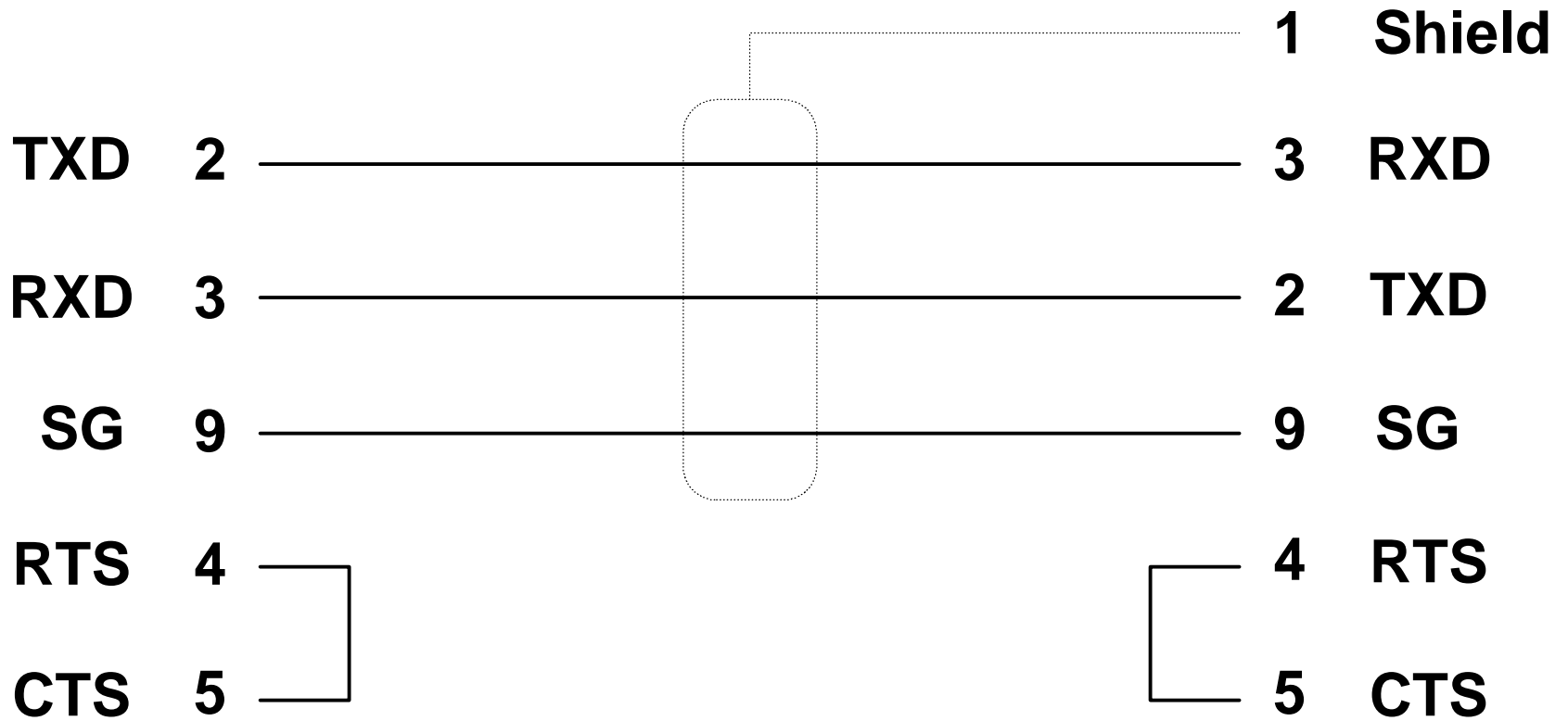

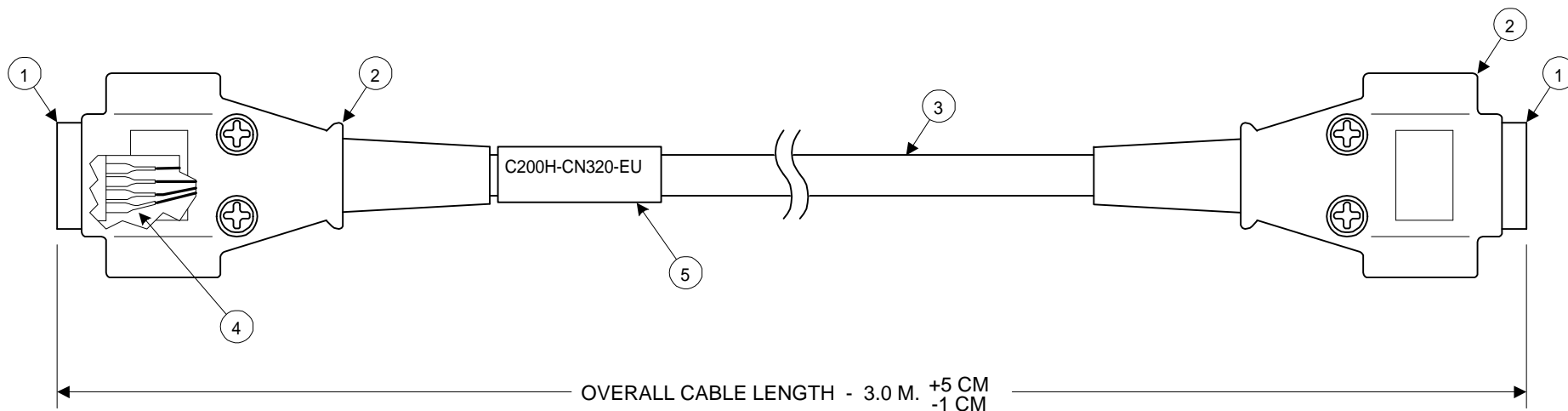

**CABLE C200H-CN320-EU**

1. DE-9 MALE CONNECTOR WITH SOLDER CUPS, QTY 2
2. OMRON DE-9 BACKSHELL W/ 2.6MM JACK SCREWS, QTY 2  
OMRON CAT. NO. XM2S-0911, PIM NO. 4584252-0
3. 3 CONDUCTOR, 24 AWG STRANDED, FOIL SHIELD, PVC JACKETED CABLE\*
4. HEAT SHRINK TUBING TO COVER SOLDERED CONNECTION, BOTH ENDS
5. HEAT SHRINK TUBING, WHITE WITH PRINTED PART NUMBER AS SHOWN IN BLACK, 8 PT. HELVETICA TYPE. POSITION APPROXIMATELY AS SHOWN.

\* RECOMMENDED: CAROL #C0743, 6 CONDUCTOR CABLE

	FROM PIN	TO PIN	
TXD	2	3	RXD
RXD	3	2	TXD
	nc	4 to 5*	
	4 to 5*	nc	
+5	6	nc	
COM	9	9	COM
	nc	1 to SHIELD	

\* JUMPER PINS 4 TO 5 IN EACH CONNECTOR

-	-	-	-	-	APPROVAL	DATE	MATERIAL: -	<b>S-SERIES PT to C-CV SERIES CPU PORT</b>		
-	-	-	-	-	DRWN <b>OBA</b>	<b>11-28-95</b>	FINISH: -			
-	-	-	-	-	CHCKD -	-	TOLERANCE: -	UNITS: <b>ENGLISH</b>	DRWG NO: <b>PFP0018-A</b>	
-	-	-	-	-	APRVD -	-		SCALE: <b>NONE</b>	FILE NAME: -	SIZE: <b>A</b>
REV	DESCRIPTION	COS NO.	DATE	SGND	-	-		SHEET: <b>1 OF 1</b>	<b>OMRON</b> Omron Electronics, Inc. Omron Manufacturing of America	

NT11S, NT20S, NT30,  
NT30C, NT600S,  
NT620C/620S

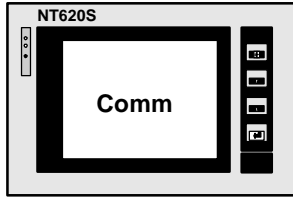

9-pin male

**Cable Part Number**  
C200H - CN320 - EU  
C200H - CN520 - EU

CV500 - LK201 (Port 2)  
CVM1 built-in port  
C200HS built-in port  
CQM1 built-in port  
CPM1- CIF01  
IDSC built-in port

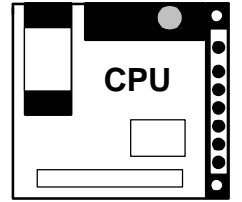

9-pin male

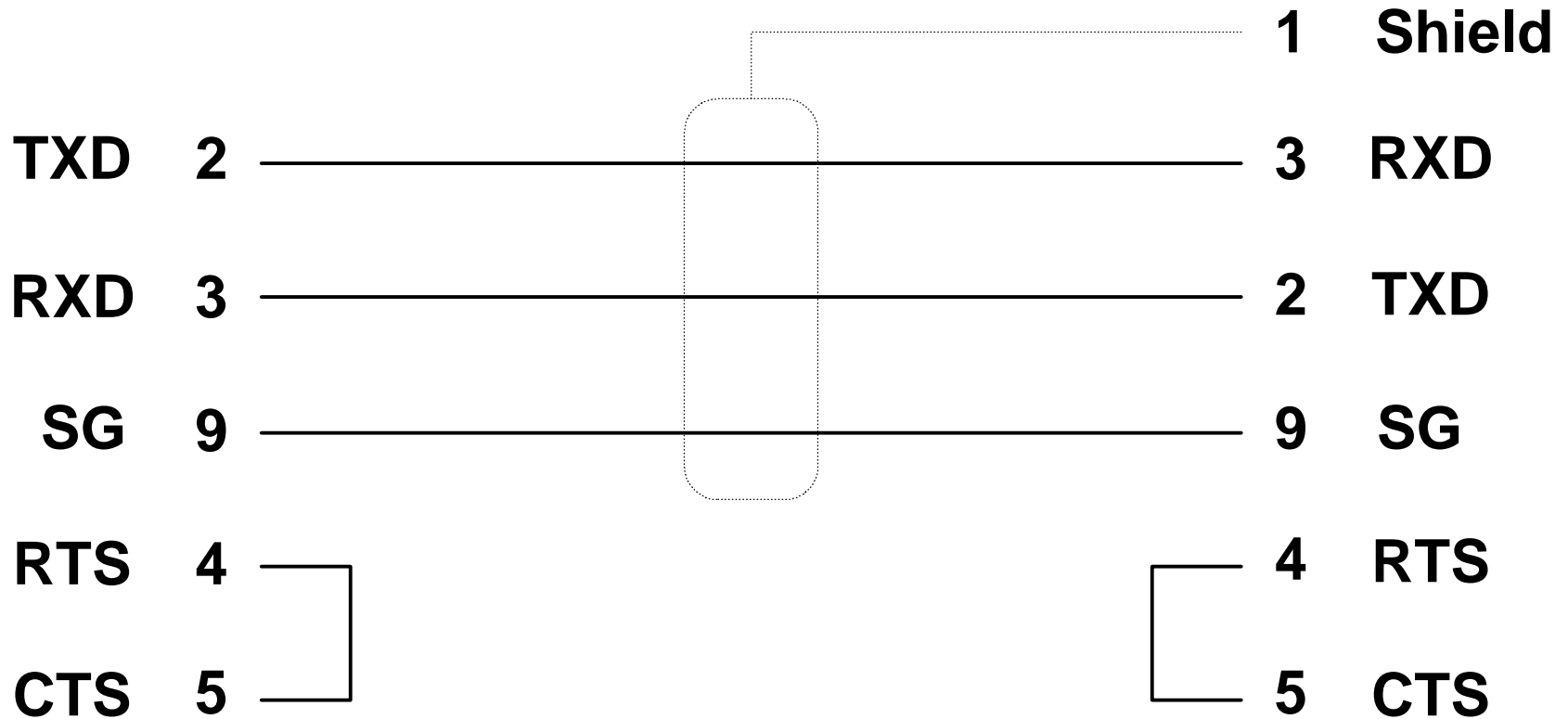



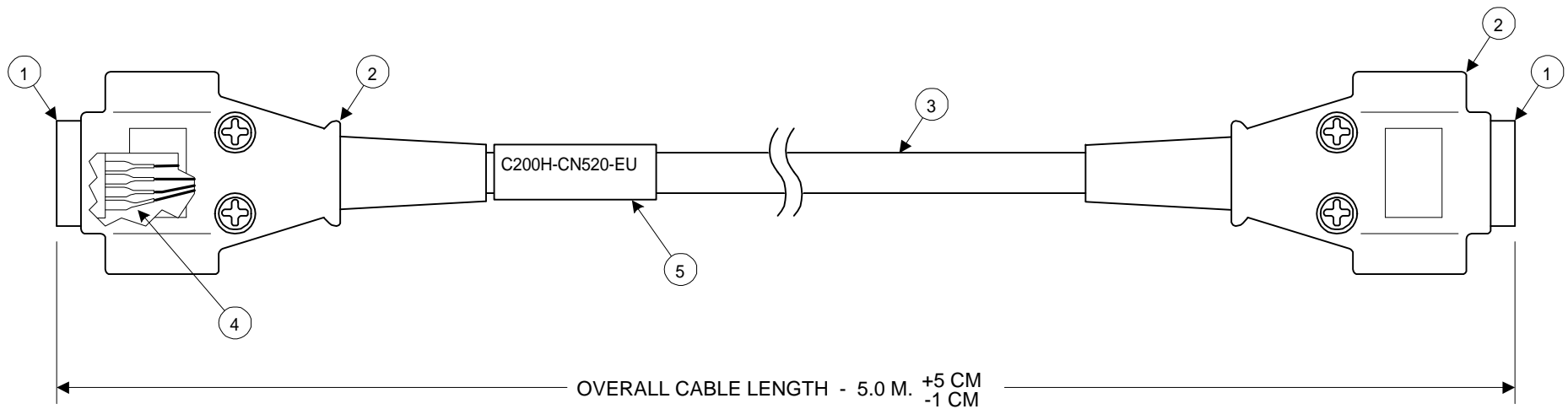

**CABLE C200H-CN520-EU**

1. DE-9 MALE CONNECTOR WITH SOLDER CUPS, QTY 2
2. OMRON DE-9 BACKSHELL W/ 2.6MM JACK SCREWS, QTY 2  
OMRON CAT. NO. XM2S-0911, PIM NO. 4584252-0
3. 3 CONDUCTOR, 24 AWG STRANDED, FOIL SHIELD, PVC JACKETED CABLE\*
4. HEAT SHRINK TUBING TO COVER SOLDERED CONNECTION, BOTH ENDS
5. HEAT SHRINK TUBING, WHITE WITH PRINTED PART NUMBER AS SHOWN IN BLACK, 8 PT. HELVETICA TYPE. POSITION APPROXIMATELY AS SHOWN.

\* RECOMMENDED: CAROL #C0743, 6 CONDUCTOR CABLE

	FROM PIN	TO PIN	
TXD	2	3	RXD
RXD	3	2	TXD
	nc	4 to 5*	
	4 to 5*	nc	
+5	6	nc	
COM	9	9	COM
	nc	1 to SHIELD	

\* JUMPER PINS 4 TO 5 IN EACH CONNECTOR

-	-	-	-	-	APPROVAL	DATE	MATERIAL: -	<b>S-SERIES PT to C-CV SERIES CPU PORT</b>		
-	-	-	-	-	DRWN <b>OBA</b>	<b>11-28-95</b>	FINISH: -			
-	-	-	-	-	CHCKD	-	TOLERANCE: -	UNITS: <b>ENGLISH</b>	DRWG NO: <b>PFP0019-A</b>	
-	-	-	-	-	APRVD	-		SCALE: <b>NONE</b>	FILE NAME: -	SIZE: <b>A</b>
REV	DESCRIPTION	COS NO.	DATE	SGND	-	-		SHEET: <b>1 OF 1</b>	<b>OMRON</b> Omron Electronics, Inc. Omron Manufacturing of America	

CV500 - LK201 (Port 2)  
 CVM1 built-in port  
 C200HS built-in port  
 CQM1 built-in port  
 CPM1- CIF01  
 IDSC built-in port

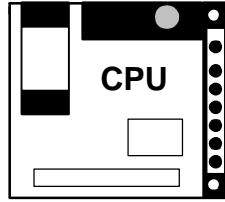

9-pin male

**Cable Part Number**  
 C200H - CN320 - EU  
 C200H - CN520 - EU

PT (NT600M - LK201)

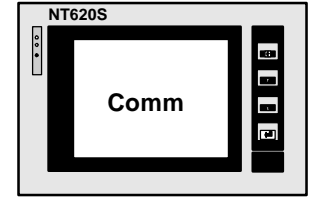

9-pin male

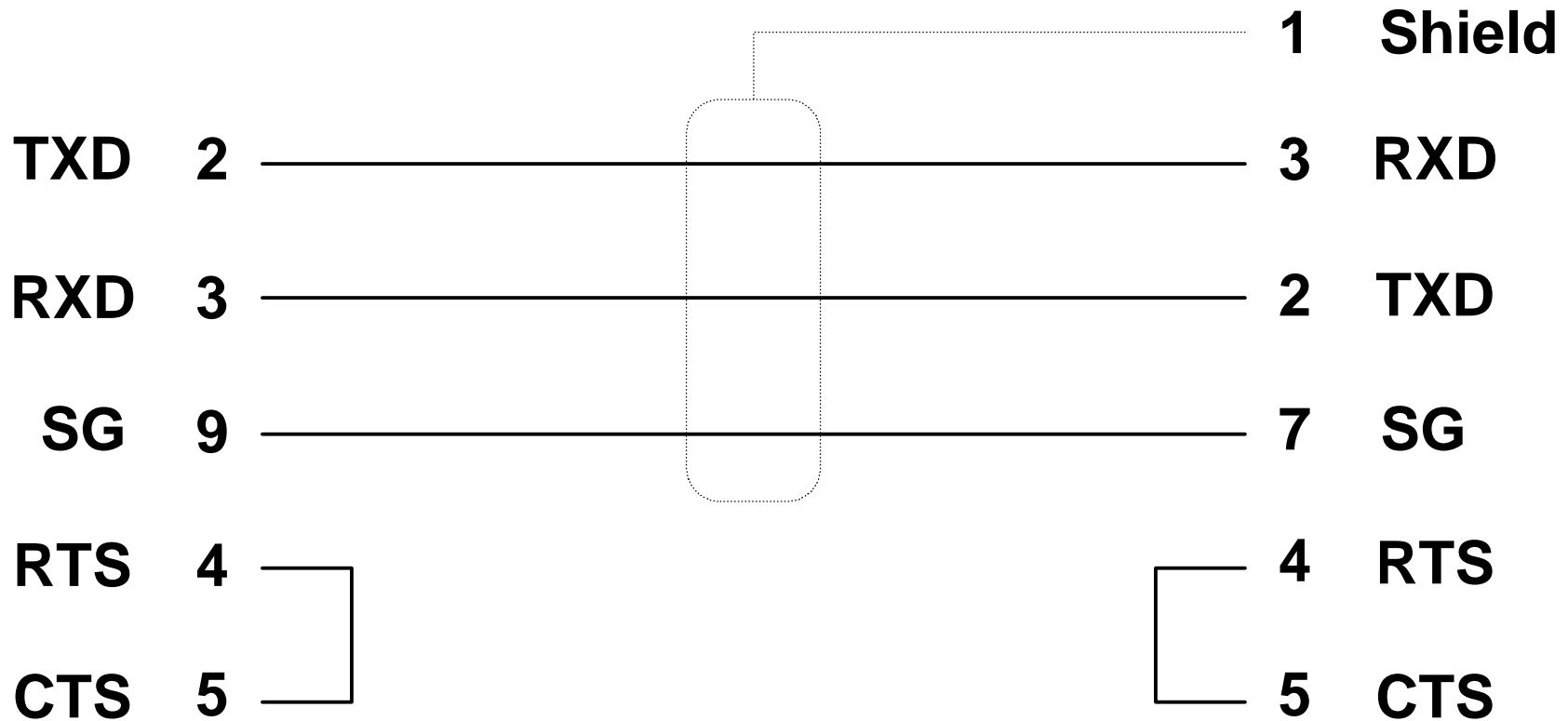



All C\*\*H Series  
PLC's

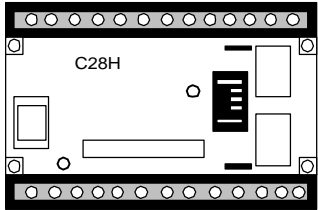

9-pin

**Omron does not make a cable  
for this configuration**

NT11S/NT20S/NT30  
NT600S/NT620

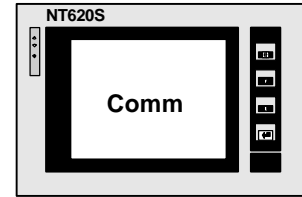

9-pin

